

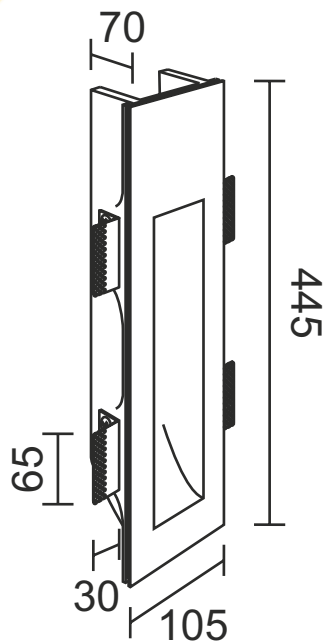

СВЕТОДИОДНОЕ ОСВЕЩЕНИЕ
LEDRON



MW6030

1

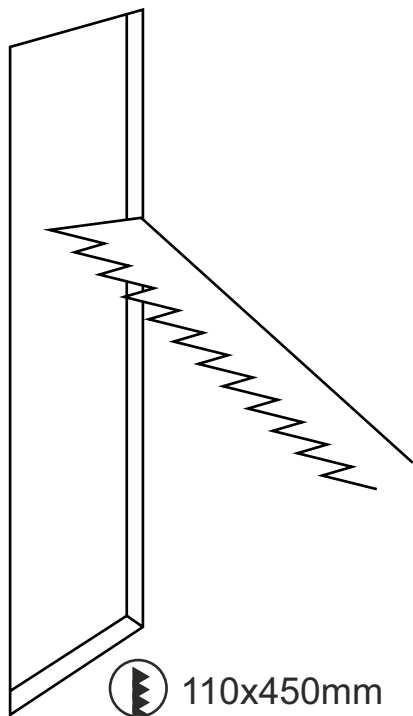

110x450mm

2

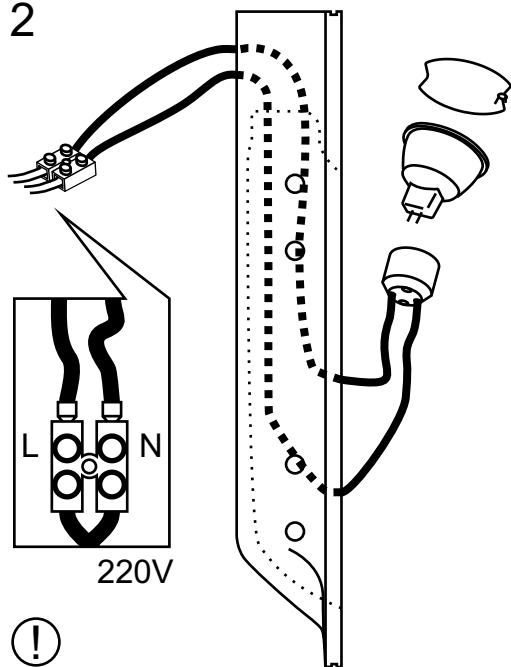

220V



Установка светильника осуществляется при выключенной электрической сети

3

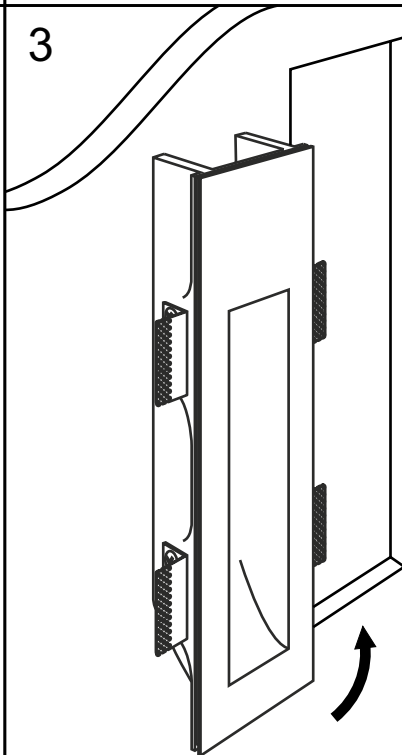

4

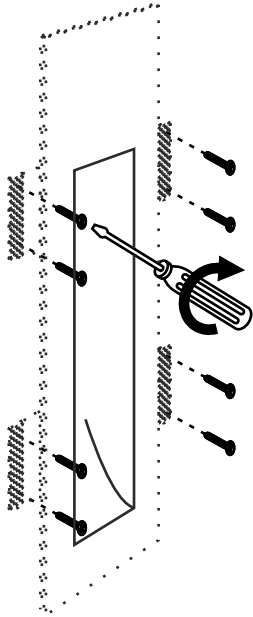

5

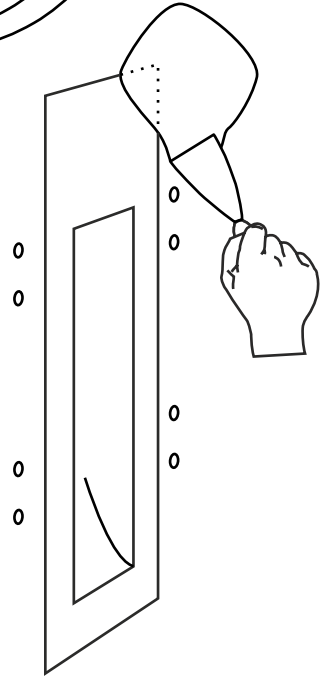

6

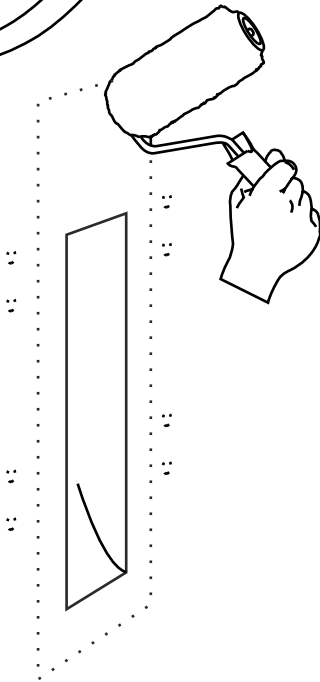

7

